

INSTRUCTION
MANUAL

MODEL: LAIO1



LITHEAUDIO



THANK YOU FOR CHOOSING LITHE AUDIO

MODEL LAIO1

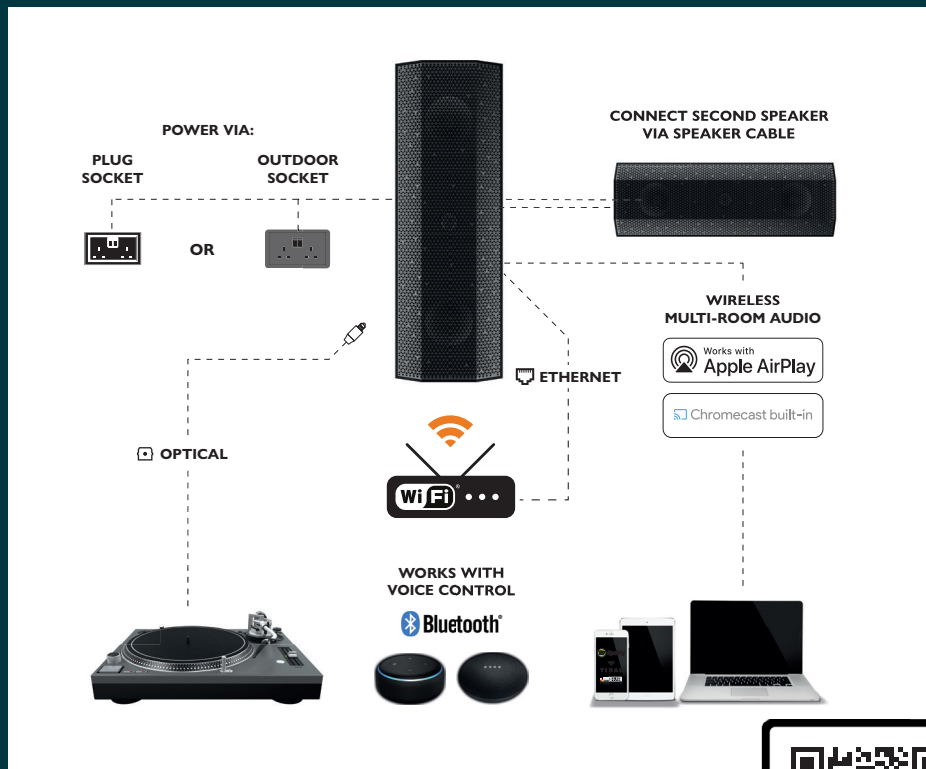
Innovative design and advanced engineering are built in to our iO1 series of wireless Wi-Fi surface mount speakers. Designed for easy installation and high quality sound, within seconds each room or outdoor space is setup and ready. This manual describes the installation of iO1 series speakers.



For video installation guides and advice visit:
SUPPORT.LITHEAUDIO.COM



SCAN ME

SHARE YOUR INSTALL TO WIN



We're giving you a chance to win a selection of Lithe Audio products simply by sharing a photo of your installed ceiling speakers. Show off your installation and creativity by tagging us in your photo and using the hashtag #LitheAudioInstall Good luck!



SCAN ME

REGISTER YOUR PRODUCT

Register your Lithe Audio product today and unlock exclusive benefits! By registering your product, you'll receive warranty protection, access to software updates, and priority technical support. Plus, you'll be the first to know about new products and promotions.



SCAN ME

LITHE PLAYLIST'S FOR EVERY OCCASION

Looking for the perfect playlist for any occasion? Look no further than Lithe Audio's curated playlists! From soft jazz for evening relaxation to summer vibes for a garden party, our playlists have got you covered. Get the party started with Lithe Audio's playlists today.



SCAN ME

IMPORTANT SAFETY WARNING

BEFORE USE PLEASE READ COMPLETELY AND USE THE PRODUCT IN ACCORDANCE WITH THESE SAFETY INSTRUCTIONS.

Before commencing any electrical work ensure the supply is switched OFF at the mains. Either by switching off the consumer unit or by removing the appropriate fuse. This product should be installed in accordance with the relevant sections of the building regulations code and in accordance with the latest edition of IEE regulations (BS 7671).

If the unit is to be used as a replacement for an existing product, remove the existing unit from its location and disconnect the wiring. Connect the wires as shown in diagram. Ensure terminals are properly tightened and ensure no bare wires are visible. When fitting the speaker into the ceiling, ensure no wires are trapped.

READ THE INSTRUCTIONS CAREFULLY BEFORE STARTING THE INSTALLATION PROCESS AND KEEP THEM SAFE FOR FUTURE REFERENCE.

- Failure to follow the instructions in this guide voids all warranties on your speakers.
- Warning: Do not use the product in water.
- Warning: Do not install speaker directly above any heat sources such as radiators, or other apparatus that produce heat.
- Protect the power cable from being damaged, do not over stretch cable.
- Only use attachments/accessories specified by the manufacturer Lithe Audio.
- Turn off the power to the speaker when unused for long periods of time.
- A Fire and Acoustic speaker hood must be used in accordance with UK building and IEE Regulations with a fire rating of up to 60 minutes, is Parts B, L, C and E compliant.
- Do not open the back cover to the speaker as this protects the PCB as this will invalidate the warranty and could cause electric shock.
- Ensure speaker location is free from obstructions such as electrical conduit, HVAC ducts or Water lines.

By default, if no signal or no user input is present for 20 minutes the product will automatically go into standby to save power. Standby Mode power consumption is less than 0.5 watts.

The product has no network standby mode due to functional requirements, so the unit will go into Standby(0.5W) mode directly after 20 minutes of no audio input, no audio output and no user input. Standby Mode power consumption is less than 0.5 watts

USA REGULATIONS

BEFORE USE PLEASE READ COMPLETELY AND USE THE PRODUCT IN ACCORDANCE WITH THESE SAFETY INSTRUCTIONS.

In accordance with US National Electrical Code. It is Important to hire a qualified electrician or contractor who fully understands the NEC codes and regulations to ensure that your electrical installation is in compliance with all relevant safety standards, as each state or locality may have their own additional or stricter codes to be followed.

IMPORTANT: Before commencing any electrical works, locate your electrical panel for your home or building. Turn OFF the power to panel by flipping the main breaker.

INSTALLATION GUIDE IN ACCORDANCE WITH US NEC CODE

A typical installation guide for fitting Lithe Audio iO1 Speakers into your home.

The Lithe Audio speaker is designed for outdoor use IPX6 rated. Recommend the plug is terminated into an outdoor outlet Example: Taymac in use cover outlet (NM410C). Ensure power supply unit is fixed above the ground 6 inches.

Connect the DC connector into the dc receptacle on the speaker push into place to ensure a solid connection.

READ THE INSTRUCTIONS CAREFULLY BEFORE STARTING THE INSTALLATION PROCESS AND KEEP THEM SAFE FOR FUTURE REFERENCE.

- Failure to follow the instructions in this guide voids all warranties on your speakers.
- Warning: Do not use the product in water.
- Warning: Do not install speaker directly above any heat sources such as radiators, or other apparatus that produces heat.
- Warning: Do not install insulation directly on top of the speaker
- Protect the power cable from being damaged, do not over stretch cable.
- Only use attachments/accessories specified by the manufacturer Lithe Audio.
- Turn off the power to the speaker when unused for long periods of time.
- Ensure the back housing cover to the speaker is fully secured and fixed in place as without this, shall invalidate the water proofing integrity to the speaker.
- Ensure speaker location is free from obstructions such as electrical conduit, HVAC ducts or Water lines.

KNOW YOUR SPEAKER

The Lithe Audio iO I range of speakers have various inputs and outputs as listed below:

SPEAKER OUTPUT - To connect one additional passive (Slave) speaker (Gold Plated)

OPTICAL INPUT - To connect directly from TV Output, CD Player, DVD Player etc..

POWER INPUT - To connect (as supplied) Power Driver

ETHERNET INPUT/OUTPUT - To connect ethernet RJ45 cable for hard wired data connection

Built in Amplifier & Wi-Fi chipset

2 x 3" Waterproof coating paper cone

0.75" Waterproof coating silk dome tweeter

Aluminium Grille

Magnets for Cover

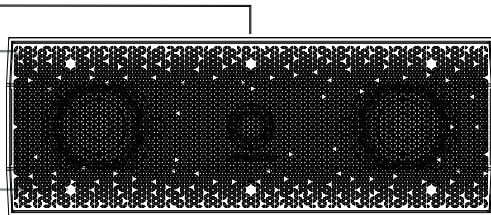

IPX6 Rated all weather casing

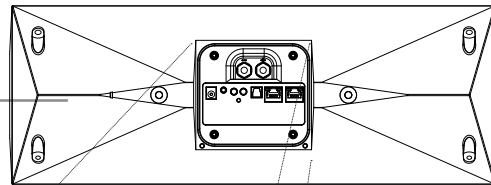

Speaker output (Right)

R+ (Red) R- (Black)

Connection Reset Button

LED indicator

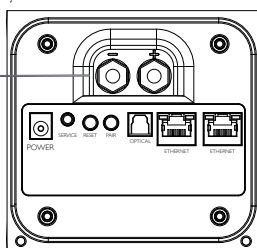

Power input
24V/5.25A

Optical input

Ethernet in / out

In built over voltage, under voltage, over temperature, and short circuit protection, if there is an electrical fault, the power supply to the amplifier will cut off automatically and restart when the speaker has stabilised.

BOX CONTENTS

Please ensure you read the entire instruction manual carefully before you commence any work. Carefully unpack the speakers from the packaging. Please check to ensure all the parts shown below are included.

If any parts of the speaker appear damaged, please contact your dealer/reseller immediately or contact support@litheaudio.com for contact details.

MODEL iO I

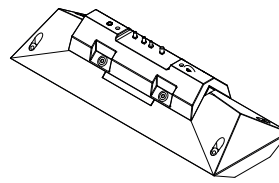

iO I SURFACE MOUNT SPEAKER WITH MOUNTING BRACKET



SPEAKER GRILLE

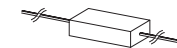

POWER DRIVER WITH 5M CABLE

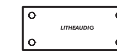

MOUNTING GUIDE

PAIR MODELS ALSO INCLUDE

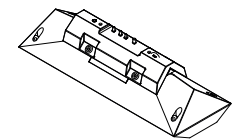

PASSIVE iO I SPEAKER



7M SPEAKER CABLE

PREPARATION EQUIPMENT YOU WILL NEED

Listed below is the hardware equipment needed to install the speaker, with the addition of a ladder to ensure the installation is done safely. A mounting template is included in the box.

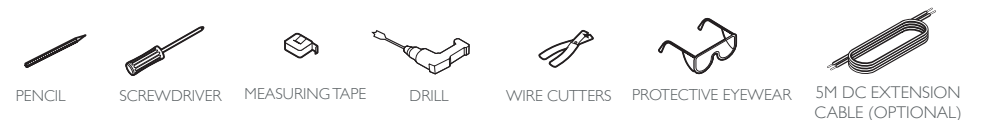

CABLE ASSEMBLY (FIG 1)

For all the mounting options you will need to follow these steps

1. Remove the rear cable enclosure as shown (4 positions)
 2. Remove the 3 screws as shown which fixes the metal pressure plate into place and remove both.
 3. Remove the Rubber cable clamp from the plastic rear cover.
 4. Insert the speaker; power; ethernet, optical cables through the rear cover opening and through rubber cable clamp into the position on the back of the speaker.
- CHECK the cable has been pushed and secured into place.
5. Place the rear cover back into place and fasten (4 positions)
 6. Push back the rubber cable clamp and fit around the cables and push into place making a water tight seal. Be careful not to pull on the cables during assembly

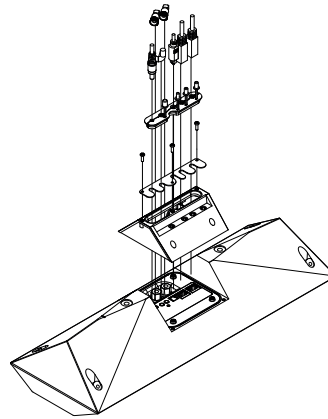
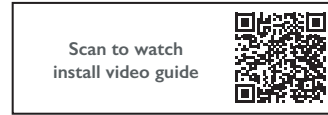

2. WALL MOUNT

With 3 positions options this method is ideal for any wall mount application where you want to focus audio and direct to a indoor or outdoor seating area.

1. Using the hole template, mark out the holes on the wall, make sure to check for water pipes or electrical cable before drilling holes for wall plugs (2 positions).
2. Fix the mounting bracket to the wall using m4 x 40mm (2 Positions)
3. As per fig1 attach the cables into the back of the speaker
4. Remove metal grille and the rubber bungs as shown, insert the m4 x 90mm screws through the speaker.
5. Ensure to add the spacers 2 positions between speaker and wall bracket.
6. Index the wall mount on speaker groove. Be careful not to over tighten the screws. Refit the 2 rubber bungs and metal grille.

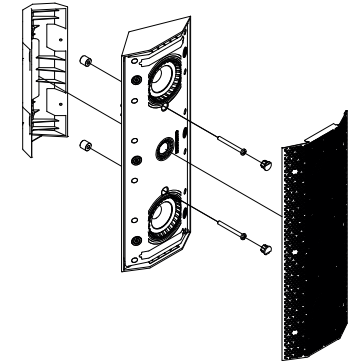
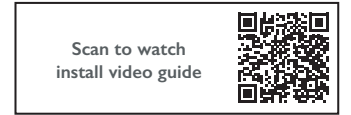

1. FLUSH MOUNT

Ideal for any corner such as eaves in the garden or corners of rooms. You can mount horizontally or vertically.

1. Using the hole template, mark out the holes on the wall, make sure to check for water pipes or electrical cable before drilling holes for wall plugs (4 positions).
2. As per fig1 attach the cables into the back of the speaker.
3. Remove metal grille (magnetic) and the 2 x rubber bungs as shown, insert the m4 x 90mm screws through the speaker.
4. Ensure to add the spacers 4 positions between speaker and wall bracket. Be careful not to over tighten the screws.
5. Refit the 2 rubber bungs and metal grille.

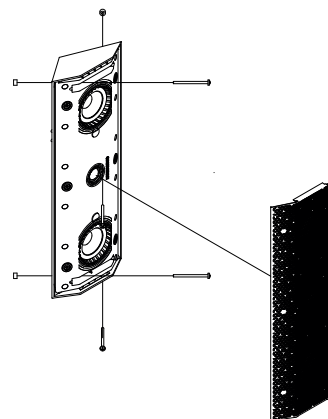
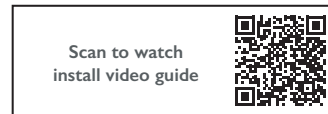

3. COUNTER TOP

Ideal for sitting on a bookcase, dining room sideboard, a desk or above a kitchen unit.

1. Attach the mounting bracket to the speaker as shown using m4 x 10mm (2 Positions)
2. As per fig1 attach the cables into the back of the speaker
3. Carefully rest on the desktop for horizontal counter top position.

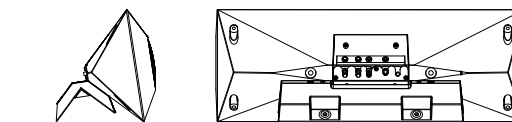
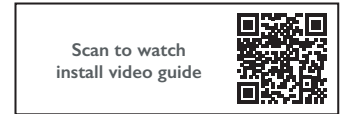



MOUNTING KIT SOLD SEPARATELY

4. PENDANT MOUNT

If you have purchased the additional Pendant mounting Kit please follow the steps below to fit into the speaker:

1. As per fig 1 attach the cables into the back of the speaker
2. Remove metal grille and the rubber bungs as shown, insert the m4 x mm screws through the speaker.
3. The screw fixing shall protrude through the back of the speaker by 10mm. Fix the pendant eyelet to protruding screws (2 Positions)
4. Ensure to tighten but not overtighten. Where required you can use 3M thread lock. (not supplied)
5. With the eyelets in place you can now suspend from your ceiling via metal wire or hangers to suit. (not supplied)

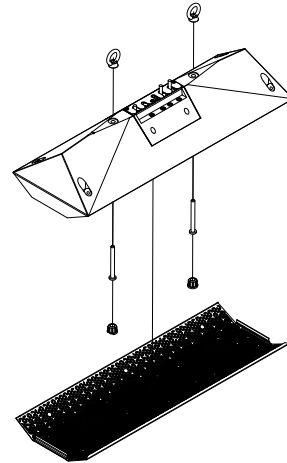
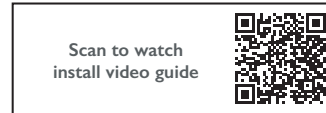

IMPORTANT: BEFORE COMMENCING ANY ELECTRICAL WORK ENSURE THE SUPPLY IS SWITCHED OFF AT THE MAINS. IF YOU ARE UNSURE HOW TO FIT SEEK HELP FROM A PROFESSIONAL ELECTRICIAN / INSTALLER

1. Mark out the position of the speaker using a tape measure and mark using a pencil with the template supplied. Check to make sure no obstruction is present prior to drilling holes.

2. Use suitable screws and wall plugs to ensure a secure fit to the wall or surface the speaker is being mounted to.

3. INDOOR USE:

Plug in or Cut the plug off and terminate into fused spur (5A fuse) OR connect plug into plug socket directly.

4. OUTDOOR USE:

DO NOT CUT THE PLUG OFF THE POWER SUPPLY AS THIS IS NOT PERMITTED. Plug into an outdoor plug socket only.

GARDEN SPIKE SOLD SEPARATELY

5. GARDEN SPIKE

If you have purchased the additional Garden Spike Kit please follow

1. Attach the spike arm to the back of the wall mounting bracket using fixing. (2 Positions)
2. As per fig 1 attach the cables into the back of the speaker
3. Follow the steps in the wall mounting to attach wall bracket to the speaker.
4. Attach the spike to the upright of the spike stem using fixing (4 positions)
5. If bolting the spike to a patio or flat slab, use the metal base plate and fix with 1 fixing. Where required bolt through to the floor for permanent fixing (4 positions)

Note: To adjust the angle of the speaker loosen the nut and fasten back at the set angle required

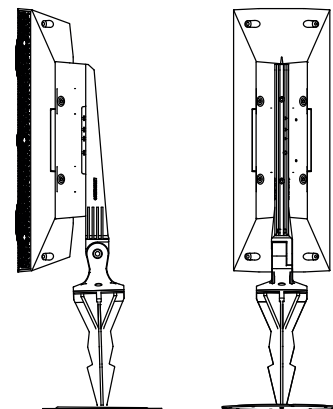
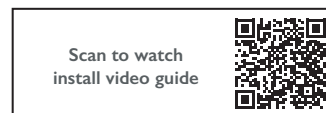

PAINTABLE GRILLES (INDOOR USE ONLY)

Do NOT paint the speaker grilles if using in an outdoor application. Lithe Audio does NOT recommend spray painting as the paint may flake off over time if used in an outdoor application. For Indoor use you can use spray paint to colour any colour required. Apply 2x Thin coats from 30cm distance.

YOUR HOME WI-FI NETWORK

To enable the Lithe Audio Wi-Fi ceiling speakers, your device must be on the same network.

- Ensure your network has a high speed internet connection, as the speakers are designed to provide you with free online software/firmware updates.
- High speed DSL/cable modem, or fiber to the home broadband is recommended for best possible playback of music services.
- Lithe Audio communicates over a 2.4GHz & 5GHz Wi-Fi home network supporting 802.11 a, b, g, n, ac wireless technology only.
- For larger homes where Wi-Fi signal is not stable, we suggest adding access points/mesh network to strengthen the network or updating your router to a higher specification model to suit the demand OR connect via hard wired ethernet connection.
- For connections to computer or NAS drive for playing personal music library, we recommend for best performance connecting via Ethernet cable.

LITHE AUDIO APP SETUP

- To enhance your listening experience download Lithe Audio app via the app store on your device follow the setup procedures within this instruction manual.
- The app will allow you to setup singular rooms, groups of speakers for multiroom
- You can set the speaker sound settings, equalizer & speaker profiles for each mounting method.

STATUS INDICATOR LIGHT

Located on the rear of the speaker, the LED Indicates the status of your speaker:

- Red solid: Speaker booting up
- Red slow flash (3s 1 time): Speaker under standby mode, waiting for user operation
- Green solid: Speaker is active and connected to Wi-Fi
- Green slow flash(1s 1 time): Speaker trying to connect to the preconfigured Wi-Fi
- Solid purple: Speaker under WiSA mode
- Green quick flash(1s 4 times): Speaker in WAC/SAC mode, user to configure Wi-Fi
- Green flash:When device is playing the Spotify connect & Cast playbacks.
- Blue Solid : When device is connected to Bluetooth.
- Blue flash:When device is playing the Bluetooth connect & playbacks.

OPTIONAL ETHERNET CONNECTION

The hardware data connection ports allow to connect to the speaker via ethernet cable for data using either of the RJ45 ports and a CAT5 or CAT6e cable.

This is particularly useful in outdoor applications where the WiFi signal may be poor in certain areas of the garden or in indoor locations where walls may be thick or commercial applications where a lot of wifi signals are present.

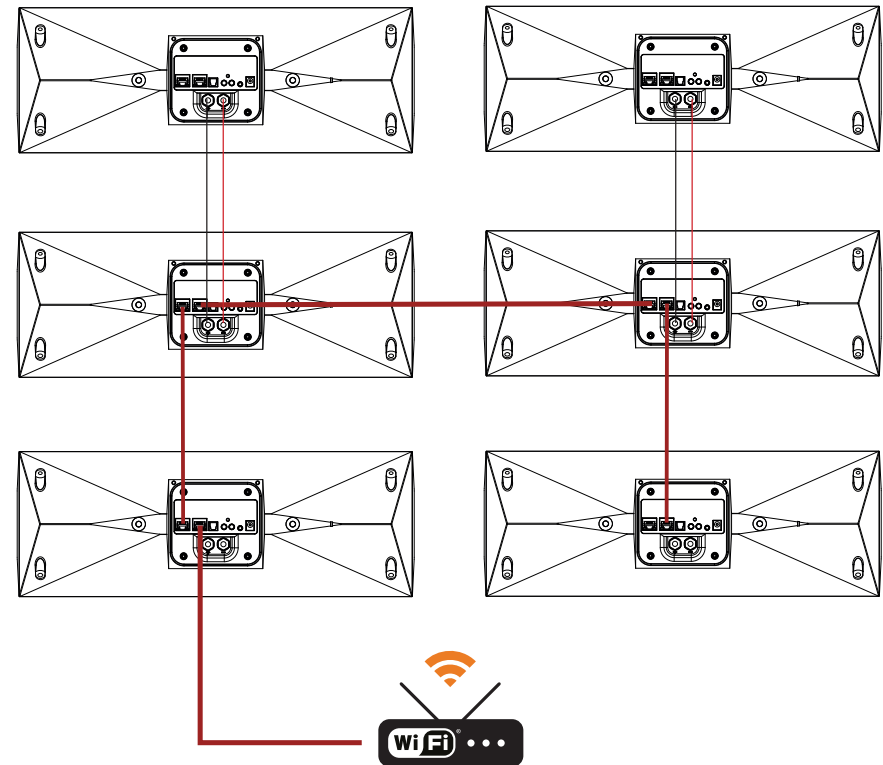

RESET & PAIR BUTTON

Reset button: short press is used to reset the speaker and clear the previous wifi and Bluetooth configuration records.

Pair button is used to put the device in WiSA mode.

SETUP FOR APPLE IOS

Download on the
App Store

OPEN CAMERA & SCAN TO
DOWNLOAD THE APP

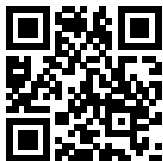

AirPlay 2

Works with
Apple AirPlay

NOTE: If you are connecting via ethernet cable no setup is necessary

1. Ensure the Wi-Fi speaker is connected to the power supply and is turned on, the LED indicator will flash red slowly.

2. Press and hold the 'Connection Reset Button' for 5 seconds & release, the LED indicator will flash Green and the speaker is now ready to connect to your Wi-Fi network.

3. Open the Wi-Fi setting menu on your phone or tablet.

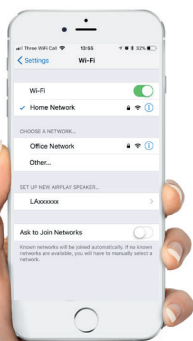

4. Select the new AirPlay speaker listed you would like to add to your network.

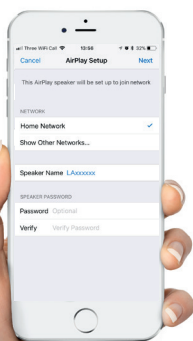

5. Select your network and change the 'Speaker Name' to something easily identifiable e.g. Kitchen and click Next.

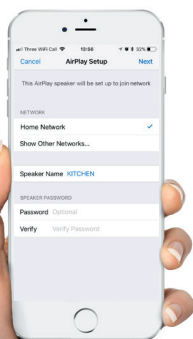

6. The Lithe Audio Wi-Fi speaker setup is now complete, return to the Lithe Audio app.



To play directly to speaker(s) using a iOS devices (iPad, iMac, iPhone, Apple TV etc) you can connect via AirPlay 2. Please follow the steps below:

ENSURE THE SPEAKER IS CONNECTED TO THE POWER SUPPLY, AND THE WIFI NETWORK.

Note: When using AirPlay 2 the Lithe app grouping and playback functions for multiple speakers becomes redundant. The ability to play any source is now possible. As well as playing with other brands in a multi room environment.

1. Swipe down from the top right of the screen to open control panel.



2. Click on the right corner icon to show available AirPlay devices.



3. Audio display screen shall show available devices to play music through as per list.



4. Select the speaker(s) to play music through open any app and play your music.

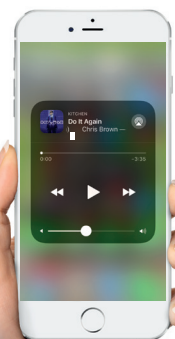

SETUP FOR GOOGLE HOME

1. Download the Google Home app from the Google Play store
2. Ensure the Wi-Fi speaker is connected to the power supply and is turned on, the LED indicator will flash red slowly.
3. Press the + top left hand corner, click set up device, choose home to start looking for devices on your network, choose Speaker; Next.
4. Open Google Home and click the + sign top left hand corner

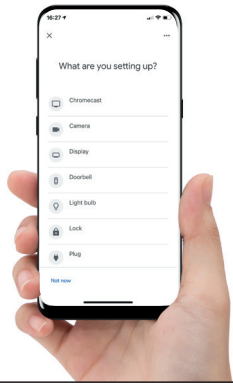

5. Click set up device, New devices Setup new device

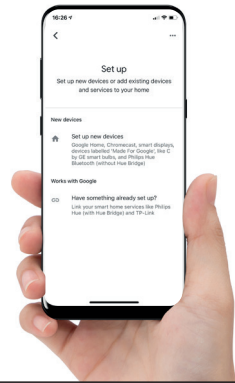

6. Select existing home or create new home to start looking for devices

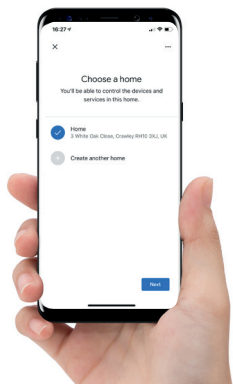

7. Select speaker; Next, click on Lithe Audio Speaker all set.

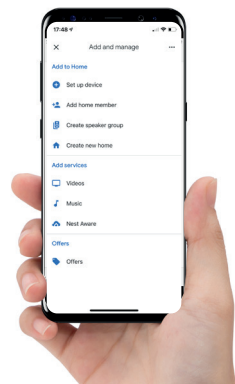

Chromecast Built-in



To play directly to speaker(s) using Google Cast. Please follow the steps below:

ENSURE THE SPEAKER IS CONNECTED TO THE POWER SUPPLY, AND THE WIFI NETWORK.

Note: When using Google Cast the Lithe app grouping and playback functions for multiple speakers becomes redundant. The ability to play any source is now possible. As well as playing with other brands with Google Cast built in within a multi room environment.

1. To group speakers, click +, create speaker group

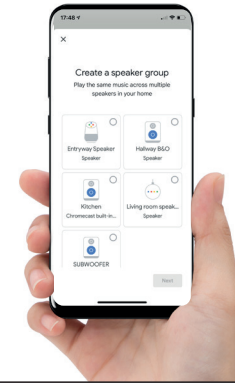

2. Click on the speakers you want to group, next, name group

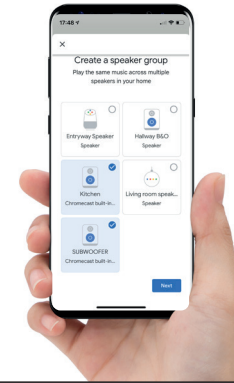

3. Audio display screen shall show available devices to play music through as per list

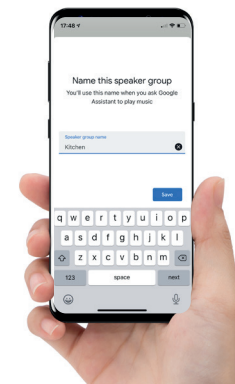

4. Select the speaker to play music through and press play on your source player

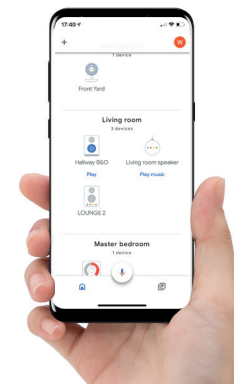

SPOTIFY CONNECT



Use your phone, tablet or computer as a remote control for Spotify.

Go to www.spotify.com/connect to learn how.

Note: The Spotify software is subject to third party licenses found here: www.spotify.com/connect/third-party-licenses

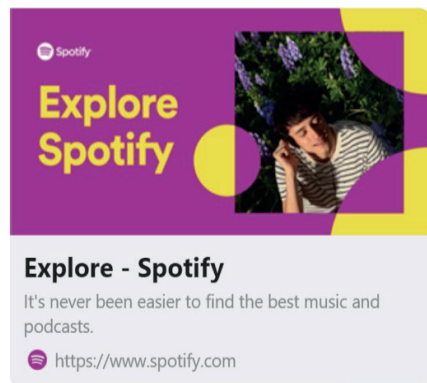

HARD WIRED OPTICAL

To connect other devices such as CD player, BluRay player etc) to play through the Wi-Fi speakers please follow the steps below:

Optical Connection:

To play music via speaker Optical connection connect an Optical cable to the speaker and play through your device. Within the Lithe Audio App click on source to activate Optical to be able to play through the speaker:

Volume adjustment for optical is done through the Lithe App.

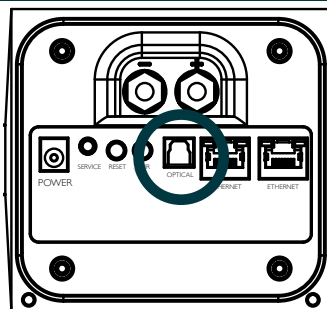

CREATE STEREO PAIR

PLEASE NOTE: iO I DOES NOT INCLUDE PASSIVE SPEAKER.

The Lithe Audio Master iO I surface mount speaker is able to connect to and power an additional passive speaker and output the right speaker channel for Stereo.

Use wire cutters to strip the ends of the speaker cable (if required).

SPEAKER

- RMS Power: 100W RMS (2x 50W)
- Frequency Response 55Hz-20kHz (+/- 3dB)
- Sound Quality THD+N<0.01%,
- Impedance: 4 Ohms nominal (8||8)
- Sensitivity (1W/1m): 82dB
- Line In Analog (Optical), auto-detecting
- Type: Class D (Digital)
- Audio Compression: 192KHz/24bits
- Bluetooth 5.0
- Woofer: 2 x 3" waterproof coated paper cone
- Tweeter: 0.75" waterproof coated silk dome

MUSIC ACCESS

- Audio Formats Supported: MP3, WMA, AAC (MPEG4), AAC+, ALAC, FLAC, APE, WAV, OGG, LPCM
- Audio Sample Rate: up to 192kHz 24bit
- Music Services Supported by Lithe Audio include; Airable Radio, Podcast, Tidal, Deezer, Soundmachine, Amazon Music, Napster, Spotify, etc..
- Operating Systems (for stored files) Windows XP SP3 and higher; Mac OS X 10.6.8 and higher; NAS (network-attached storage) devices supporting CIFS

MULTI ROOM

- Expandable to any AirPlay2 or Google Chromecast within same Wi-Fi network

WIRELESS NETWORKING

- Wi-Fi Connectivity: Wi-Fi CERTIFIED™ 802.11 a, b, g, n, ac WPA™ - Personal WPA2™ - Personal WMM®, Wi-Fi Protected Setup™
- Wireless connectivity works on your home Wi-Fi network with both 2.4GHz/5GHz broadcast routers
- Internet connection required for access to Internet radio stations, online music services and software updates.

GENERAL

- Power Input Supply: 100-240V, 50/60Hz / 2.5A
- Transformer Output Supply : DC24V / 5.25A
- Dimensions 465 x 170 x 100mm (18.3 x 6.7 x 3.9 in)
- Weight 2.75kg (6 lbs)
- IP rating: IPX6
- Operating Temperature 0° to 50° C (32° to 122° F)
- Storage Temperature -20° to 70° C (4° to 158° F)

* Specifications subject to change without notice.

** Power Consumption depends on the type of music & volume
- Increased Bass & volume requires more power loading on the amplifier.

- Internet functionality may require payment of separate fee to a service provider.

5.15-5.25GHz Band

Operations in the 5.15-5.25GHz band are restricted to indoor use only. The working state of the two 5G modules is controlled by the internal hardware SWITCH module, 2:1 multiplexing, and the default wireless module works. By operating on APP, sending "Select" command, controlling internal hardware switch to select corresponding working wireless module, will not work at the same time.

TROUBLESHOOTING

If a problem arises, please try the troubleshooting guide below. If the problem is not listed please contact Lithe Audio Customer Service Support

Q: Speaker has not been found during setup

A: Please check power cord is correctly connected into speaker and transformer; Check the red light is ON. Press reset button for 5 seconds on the speaker (discoverable mode), green light shall flash, follow the instructions for Android or AirPlay 2 setup.

*Before commencing any electrical work ensure the supply is switched OFF at the mains.

Q: Speaker connected to AirPlay 2 but not playing through device

A: Please ensure device has good Wi-Fi strength and battery power; check the led indicator is solid green, if not press reset button for 3 secs. Failing this, turn the speaker power off then on.

Q: Device is connected to Wi-Fi speaker but no sound

A: Ensure your device volume is NOT muted, increase the volume within app and try again. Restart the app which the audio is playing from and try again.

Q: Lithe Audio App not showing connected speakers

A: Ensure your speakers green light are on, and connected as per setup. The app shall automatically find active speakers, if not, restart app or press reset on speaker for 3 secs to wake speaker to show green status light.

Q: Lithe Audio App not working correctly

A: Ensure your speaker firmware/app are up to date, OR restart/reinstall app fully.

Q: I have a new router and speakers are not visible anymore

A: If you have purchased a new router or reset the router back to default, you shall need to install the speakers again. Please follow the setup procedures for IOS or Android.

For further queries and support questions please visit www.support.litheaudio.com email us at support@litheaudio.com or via our website's live chat service (during working hours)

FCC STATEMENT

This equipment has been tested and found to comply with the limits for a Class B digital device, pursuant to part 15 of the FCC rules. These limits are designed to provide reasonable protection against harmful interference in a residential installation. This equipment generates, uses and can radiate radio frequency energy and, if not installed and used in accordance with the instructions, may cause harmful interference to radio communications. However, there is no guarantee that interference will not occur in a particular installation. If this equipment does cause harmful interference to radio or television reception, which can be determined by turning the equipment off and on, the user is encouraged to try to correct the interference by one or more of the following measures:

- Reorient or relocate the receiving antenna.
- Increase the separation between the equipment and receiver.
- Connect the equipment into an outlet on a circuit different from that to which the receiver is connected.
- Consult the dealer or an experienced radio/tv technician for help.

To assure continued compliance, any changes or modifications not expressly approved by the party responsible for compliance could void the user's authority to operate this equipment. (example- use only shielded interface cables when connecting to computer or peripheral devices).

FCC RADIATION EXPOSURE STATEMENT

This equipment complies with FCC RF radiation exposure limits set forth for an uncontrolled environment. This transmitter must not be co-located or operating in conjunction with any other antenna or transmitter. This equipment should be installed and operated with a minimum distance of 20 centimeters between the radiator and your body.

This device complies with part 15 of the FCC rules. Operation is subject to the following two conditions: (1) this device may not cause harmful interference, and (2) this device must accept any interference received, including interference that may cause undesired operation.

EUROPE

Lithe Audio declares that this product herewith complies with the requirements of the EMC Directive 2014/30/EU, Low Voltage directive 2014/35/EC, Eco-Design Directive 2005/32/EC, RoHS Directive 2011/65/EU and the R&TTE Directive 1999/5/EC when installed and used in accordance with the manufacturer's instructions. A copy of the full Declaration of Conformance may be obtained at www.litheaudio.com/support/policies.

Lithe Audio Speakers have a standby mode or remove the power cord from the AC mains.

REGULATION INFORMATION

RECYCLING INFORMATION

This symbol on the product or on its packaging indicates that this product shall not be treated as household waste. Instead please deliver it to the applicable collection point for the recycling of electrical and electronic equipment. By recycling this product correctly, you will help conserve natural resources and prevent potential negative environmental consequences. For more detailed information about recycling of this product, please contact your local council office, your household waste disposal service or the shop where you purchased the product(s) from.

THIS DOCUMENT CONTAINS INFORMATION THAT IS SUBJECT TO CHANGE WITHOUT NOTICE.

No part of this publication may be reproduced or transmitted in any form or by any means, electronic or mechanical, including but not limited to photocopying, recording, information retrieval systems, or computer network without the written permission of Lithe Audio Ltd

Use of the Works with Apple badge means that an accessory has been designed to work specifically with the technology identified in the badge and has been certified by the developer to meet Apple performance standards.

To control this AirPlay 2-enabled speaker; iOS 11.4 or later is required.

Apple, iPad, iPad Air, iPad Pro, iPhone and AirPlay are trademarks of Apple Inc., registered in the U.S. and other countries.

Windows® is a registered trademark of Microsoft Corporation in the United States and other countries.

Android™ is a trademark of Google, Inc.

Google, Chromecast built-in are trademarks of Google LLC.

The Bluetooth® word mark and logos are registered trademarks owned by Bluetooth SIG, Inc. and any use of such marks by Lithe Audio Ltd is under license. Other trademarks and trade names are those of their respective owners.

Wi-Fi CERTIFIED™ is a registered trademark of Wi-Fi Alliance®

Spotify software is subject to third party licenses found here:
<http://www.spotify.com/connect/third-party-licenses>

All other products and services mentioned may be trademarks or service marks of their respective owners.

©2023 by Lithe Audio Ltd. All rights reserved.

This warranty may not be valid if the product was purchased via an un-authorized dealer.

The warranty only applies to individual that made the original purchase, not transferable.

The purchaser must show proof of purchase by way of receipt (hard copy or digital copy)

The warranty is null and void if:

- product altered in any way from its original manufactured state
- security seal has been removed
- product defaced

No one is authorised to make or modify any warranty on behalf of Lithe Audio Ltd.



LITHEAUDIO

2 YEAR GUARANTEE

**For detailed warranty conditions please refer to the following web link
www.litheaudio.com/warranty/iO**

This Speaker is of excellent quality and construction. However, if any defects in materials or workmanship do appear during the guarantee period, we will, at our discretion, either repair or replace the defective parts, free of charge, subject to the terms and conditions of our Guarantee shown below.

This Guarantee covers both parts and labour. Carriage is not included.

This Guarantee provides benefits which are additional to, and do not affect, your statutory rights. This Guarantee does not cover the cost of returning the product to the dealer from whom it was purchased or to ourselves. This Guarantee applies only to products sold and located in mainland Great Britain. It does not cover liability in respect of or replacement of plugs, cables or fuses and also does not cover defects due to:

- Failure to use or maintain product in accordance with Lithe Audio instructions.
- The product being connected to an unsuitable electricity supply.
- Accidental damage to or abuse or misuse of the product.
- Product modification, except by Lithe Audio or approved agent.
- Dismantling of or interference with the product.

Before returning any product under this Guarantee, please check that:

- You have followed the product instructions correctly.
- Your mains electricity supply is functional.
- The defect is not due to a blown fuse.

If you wish to claim under this guarantee you should:

- Send the product, postage or carriage paid, to the dealer from whom it was purchased or to Lithe Audio direct.
- Ensure that the product is clean and packed carefully (preferably in its original carton).
- Enclose details of your name, address and telephone number and when and where the product was purchased, together with proof of purchase (e.g. a invoice or till receipt).
- Give exact details of the nature of the defect.

This Guarantee does not cover any other claims whatsoever, including, without limitation, any liability for incidental, indirect or consequential damage, nor does it cover any claims for conversion or modification or for the costs of repair carried out by any third party without the prior consent of Lithe Audio. If replacement parts are fitted to the product this will not extend the period of the Guarantee. For further advice contact the Lithe Audio customer services.

**UK
CA NI**



Lithe Audio products marked with the CE mark comply with the EC Low Voltage Directive: 73/23/EEC, Electromagnetic Compatibility Directive 89/336/EEC

LITHEAUDIO.COM

T: +44 (0) 1293 922 015 E: SALES@LITHEAUDIO.COM

